

GERMAN
POOL

光波多功能煮食锅 | CKY-298
Halogen Cooking Pot



在使用之前请详细阅读「使用说明书」及「保用条款」，并妥为保存。
Please read these instructions and warranty information carefully before use and keep them handy for future reference.

即时网上登记保用
Online Warranty Registration



使用说明书 USER MANUAL

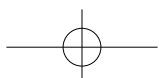

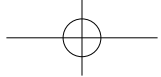

目录

安全注意事项	3
产品特点	5
产品结构	6
操作说明	7
清洁与保养	11
配件	12
常见故障及处理	13
技术规格	13
保用条款	27

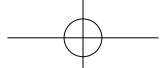

安全注意事项

重要说明

- 为安全起见，初次使用产品前请先细阅本说明书，并保存说明书，以便作参考之用。
- 本产品只供家居使用。请必须依照本说明书内的指示操作。
- 本器具不得使用木炭或类似燃料。

全新锅盖安全锁使用注意

开盖

- ① 向上打开锅盖。
- ② 锅盖完全打开后，「锅盖安全锁」会向上推，锅盖自动上锁，以固定位置。

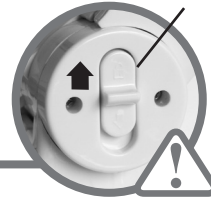

锅盖安全锁在上方，代表锅盖已上锁。

关盖

- ③ 锅盖处于打开状态时，先将锅盖手柄往后拉，然后按下锅盖安全锁。

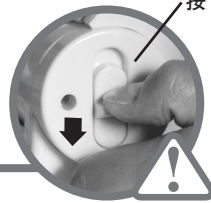

按下「锅盖安全锁」解锁。

- ④ 继续按下锅盖安全锁，并同时握着锅盖手柄将锅盖轻轻放下，直至锅盖合上。

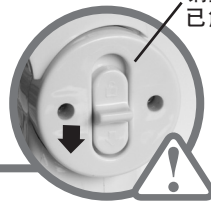

锅盖安全锁处于下方，代表锅盖已解锁。

注意：

- 切勿未按「锅盖安全锁」时用力按下锅盖，以免损坏煮食锅盖连臂。
- 关盖时需同时按「锅盖安全锁」及握着锅盖手柄，以免锅盖撞击锅身。

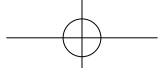

注意事项

1. 请使用专用插座，切勿与其他电器共用电源插头。
2. 启动电源前，请先将锅盖确实盖好。
3. 如放在不受热的桌上使用，必须在本产品下放置隔热垫才使用。
4. 本产品只供家居及其他相似的室内环境使用，例如：
 - 店铺、办公室及其他工作场所的员工厨房
 - 农舍
 - 酒店、汽车旅馆及其他类型的住所
 - 供住宿及早餐的旅馆
5. 本产品并非以外置时间装置或独立的遥控器操控。
6. 第一次使用或当玻璃锅锅身冷时，可先预热一下，食物烹煮效果会更佳。
7. 烹调加热时，切勿碰触锅盖或锅身，以免烫伤；待玻璃锅身冷却后，才可碰触。请勿让小孩靠近。
8. 食物必须悬空放置于层架上及不能阻塞风道。
9. 煮食时，不要在容器内放入水或与其他不通风、不耐温的器皿（如塑胶）共同使用，以免影响烹调效果。
10. 使用完毕后，请立即拔掉电源插头。
11. 清洁煮食锅机件前必须先拔下电源，待机件完全冷却后方可进行。
12. 请勿将锅盖直接冲水或泡水清洗，可用扭干之软布擦拭污渍，不可用酒精或挥发性物质（如去渍油等）擦拭上锅盖。
13. 清洗或烹调时，请避免碰撞玻璃锅身，以免造成暗伤而导致破裂。
14. 光波炉锅身与墙壁距离需大于10cm。
15. 本产品并不适宜让儿童、身体或心智残障、缺乏经验或知识的人士操作，除非该人士得到负责保障其安全的人士的监管或指引。
16. 儿童必须被监督，切勿让儿童使用、触摸或把玩本机。
17. 如发现锅盖通电后有异响或较大振动，切勿擅自打开锅盖，应先切断电源，然后立即请专业技术人员或联络本公司进行维修。
18. 如电源线损坏或发生其他故障，切勿自行拆卸、修理或改装，必须由本公司或合格的技术人员更换和维修。
19. 请勿使用受损的电线或电源插头，以防触电、引起短路或火灾。
20. 器具不能在外接定时器或独立的遥控控制系统的方式下运行。

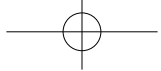

产品特点

多功能

德国宝光波多功能煮食锅能够代替十多种电器，包括：烧烤炉、传统烤箱、电饭煲、煮蛋器、电烤箱、多士炉、炖汤煲、面包机、烘干机、消毒器、爆米花机、热狗机等。

无油低脂煮食

以光波多功能煮食锅来炸薯条、炸薯饼、炸花生、炸腰果、煎鱼及腌制任何食品时，均无需加入食用油，保证吃得健康。另外，德国宝光波多功能煮食锅通过光波穿透力，让食物内的脂肪加速沸腾，逼使油脂加快排出，达到降脂肪的效果。

节能省时

光波多功能煮食锅运用热对流、热传导及热穿透三种传热方式，从而使烹调速度加快。环型光波管与热旋系统互相配合，通过圆形玻璃容器的旋流式传热，达至更佳节能效果。

绝无油烟

德国宝光波多功能煮食锅煮食时不会制造油烟或辐射，绝对是入得厨房、出得厅堂的一代环保电器。

清洗方便

光波多功能煮食锅能以光波高速旋转原理分解容器内顽固污渍，自此清洁炉具变得毫无难度。

产品材质：

玻璃锅+盖	高架/低架	煎碟	加高圈	烘盘	取物夹
玻璃	304不锈钢	不黏涂层1	410不锈钢	430不锈钢	304不锈钢



使用条件：

1. 直接接触食品
2. 拟接触的食品：所有食品类别
3. 最高使用温度及时间：250°C，119分钟
4. 是否重复使用：是
5. 使用方法：使用前应使用清水进行清洗等

产品结构

主机身

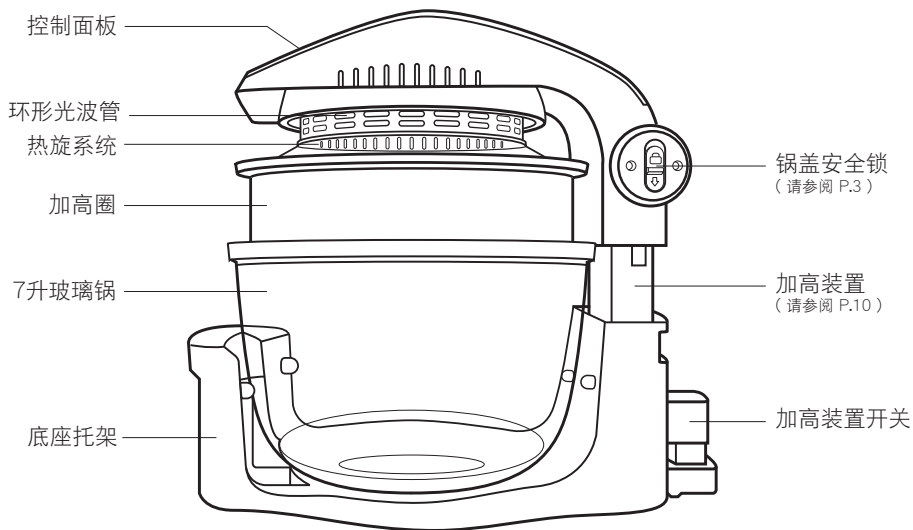

控制面板

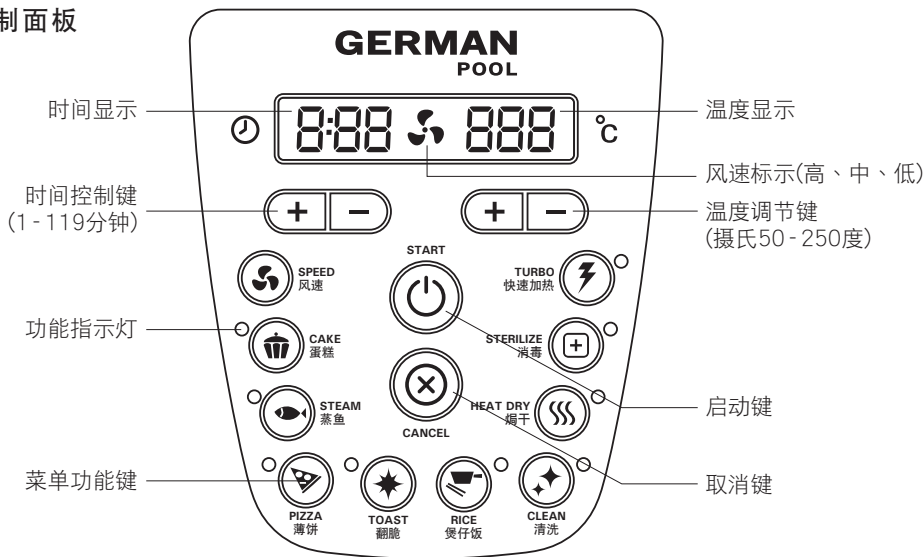

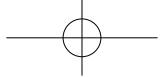

操作说明

注意事项

- 本炉设有安全开关装置，上盖掀起时，电源自动关闭，上盖放平时，则继续运作。
- 如要使用烹调器皿，请使用金属材质器皿置于层架上，使食物能被全面烘烤而不必翻动，并与锅盖保持3cm以上的距离。
- 使用过程中不可触碰玻璃锅，并切勿让小孩靠近，以免烫伤。

基本操作

开机状态：

接通电源后，会听见“嘀”的一声并同时启动数码显示屏，显示屏上显示时间和温度：表示正处于待机状态。

观看操作视频



时间调整：

时间键有“+”、“-”两个键，调整时间时，每按一下加减1分钟，若连续按住不放时间将加减10分钟。工作时间最长为1小时59分。

温度调整：

温度键有“+”、“-”两个键，按下调整温度时，第一次温度变化为50°C，然后每按一下加减10°C。工作温度最高为250°C，最低为50°C。

启动功能：

选择相应的功能后，调好所需的时间和温度，按一下启动即开始工作。

取消功能：

只需要按一下取消键便可回到待机状态。（但电机会继续工作，直至炉心温度低于100°C。如想继续使用，必须重新设置所需功能。）

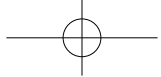

操作说明

暂停功能：

在工作过程中把锅盖掀起，显示屏的数值会停顿（工作时间和温度会自动保存起来），除取消键外，任何按键操作都会处于保护状态，同时电机和光波管也会停止工作，将锅盖放下，光波炉会恢复工作。

开始烹饪：

设置烹饪时间、温度后，按启动键后光波炉开始工作。在工作过程中可以调整时间和温度，但按下菜单功能选择键时会无反应。工作时间结束后，发热体就会停止工作，电机会继续转动直至炉心温度低于 100°C 才停止，然后会有“嘀……”响声，显示屏的数值将会重设。

菜单功能键：

按下各功能键时，会显示预设好的时间与温度，相对应的功能指示灯发光闪烁，按下启动键时光波炉就开始工作，相对应的功能指示灯停止闪烁，处于常亮状态。烹调结束，电机停止工作后，显示屏上的数值将会重设，相对应的功能菜单指示灯熄灭。注意：所有按键每按一下，都会有相应的1声“滴”的提示声。

风速调节功能：

用风速键改变电机转速，三个档分别为：高速档 - 2100 ± 100 转/分钟、中速档 - 1600 ± 100 转/分钟、低速档 - 1100 ± 100 转/分钟。预设高速档，在开始烹饪前或烹饪过程中均可调节风速（高，中，低），当风速处于任意一个档位时，液晶显示屏上代表风速标示（)会以相对应的风速旋转。当电机停止工作时风速标示则会同时停止旋转。

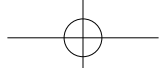

操作说明

功能键

按键	时间/温度	说明
 风速	--	可调节风速范围为：高，中，低。手动循环更替。
 煲仔饭	30分钟/250°C	专家分别按照个别食物之最佳烹调效果，预先设定不同烹调时间及温度配搭。 (用户亦可依个人喜好或食物分量随意增减时间或温度)
 蛋糕	16分钟/160°C	
 蒸鱼	40分钟/250°C	
 薄饼 (披萨)	3分钟/250°C	
 翻脆	5分钟/250°C	于短时间内以高热将食物表面烤脆，特别适合翻热已熟食物，使其口感更香脆。
 清洗	10分钟/250°C	利用光波发热管配合热旋系统，以均匀热力迅速分解玻璃器皿内之食物残渣。 注意：请待煮食锅完全冷却后才注入清水（可加入适量洗洁精）
 烘干	6分钟/90°C	以低热力且高速均匀地烤焗，有效去掉食物内多余水分。
 消毒	13分钟/130°C	光波发热管之热力将食物或食具加热，达至消毒效果。
 快速加热	40分钟/200°C	以最高温度运作40分钟。

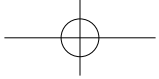

操作说明

暂停煮食

- 若要在运作中暂停烹调，可直接打开锅盖，光波管和热旋系统会同时自动暂停运作，合上锅盖则会继续烹调。
- 如欲在设定时间完结前提早结束烹调，可按“ 取消”，再打开锅盖。

锅盖安全锁 (请参阅P.3)

- 向上打开锅盖 (图1)。锅盖完全打开后，会自动上锁，以固定位置。
- 如要合上锅盖，请全程按下“ 锅盖安全锁”，同时握着锅盖手柄将锅盖轻轻放下 (图2)。



图1



图2

加高装置

- 向下按住加高装置开关，同时拉动上盖至最高位 (图3)。
- 再在玻璃锅上放上随机附送的加高圈配件，即可增大容量 (图4)。



图3





图4

注意：

在搬运产品时请勿按加高装置开关。

错误操作

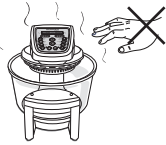
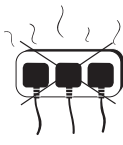
切勿如下列图示般使用煮食锅：

		
操作时用手触摸锅盖及玻璃容器	与其他电器共用电源插头	操作完毕时，立即在容器内注水

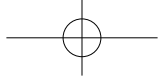

清洁与保养

1. 自动清洗功能：将适量的清水（约1/5锅体高度）注入锅内，再加入少许清洗剂，选择清洗功能，即可自动清洗锅内之油污。
2. 另一清洗方法是直接将玻璃锅拆下，以海绵沾少许清洗剂，轻轻刷洗锅身。
3. 如使用洗碗碟机，先将玻璃锅拆下，将玻璃锅及层架放入洗碗碟机清洗。切勿将锅盖放入洗碗碟机。
4. 清洁煮食锅机件前必须先拔下电源,待机件完全冷却后方可进行。
5. 清洗时，请避免碰撞玻璃锅体，以免造成暗伤从而导致破裂。
6. 锅盖因含电子部件，切勿用水浸泡清洗，玻璃锅盖请用扭干的软布抹拭即可。
7. 清洁容器、托架及配件时，可用含有温和洗洁精的水进行清洁，但必须待煮食锅完全冷却后方向进行清洁。
8. 清洗完毕后，以干布拭干锅身及锅盖部件。



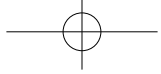

观看操作视频



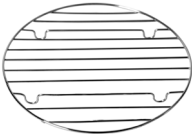
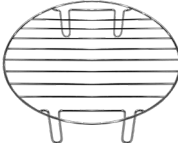

配件

随机配件

<p>低架</p> 	<p>高架</p> 	<p>取物夹</p> 
<p>适用于烹调较大型的食物 如：烤鸭、烤鸡、炖汤、煲仔饭。</p>	<p>用于需靠近发热体的食物，或配合低架进行双层煮食 如：串烧、叉烧、猪颈肉、鸡翅。</p>	<p>用以取出器皿或食物，以防烫手。</p>
<p>加高圈</p> 	<p>煎碟</p> 	<p>烘盘</p> 
<p>用以增大容量3升，尤其适用于烤鸭、烤鸡及多层煮食。</p>	<p>用于煎饺子、煎鱼、肠粉及其他食物。</p>	<p>适用于烘焙细小的食物 如：花生、薯条、药材、曲奇饼等。</p>

自选配件

<p>厨宝</p> 
<p>适用于焗饭、煲仔饭、烘焙蛋糕、汤、面等。</p>

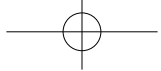

常见故障及处理

如遇以下一般故障，请按以下指示处理，如仍处理不了或未发现故障原因时，请与本公司维修服务中心联系。

注意：为安全着想，再次特别提醒，请勿自行拆卸修理。

故障现象	处理方法
首次使用光波炉时出现冒烟情况。	<ul style="list-style-type: none"> 于首次使用时，先以最高温250°C空烤5分钟，从而将机件保护油脂完全挥发出来。
光波炉不运作。	<ul style="list-style-type: none"> 检查插头是否已妥为插入插座和机身。 确认上盖已完全放下至水平位置。 (注：上盖掀起时，电源会自动关闭。)
光波炉不加热。	<ul style="list-style-type: none"> 检查是否已调至较高的所需温度。
完成烹调，马达风扇仍然转动。	<ul style="list-style-type: none"> 此乃为了散热，当温度降至100°C以下，风扇马达便会自动停止。
锅盖或玻璃锅破损。	<ul style="list-style-type: none"> 于本公司维修服务中心选购更换。

技术规格

型号	CKY-298
电压	220 V
频率	50 Hz
功率	1,000 W
温度调节范围	50 - 250 °C
时间控制范围	1 - 119 min
煮食锅尺寸 (连底座)	(H) 322 mm (W) 277 mm (D) 405 mm
玻璃容器尺寸	(H) 172 mm (Ø) 277 mm
容器容量	7 (+3) L
净重	4.34 kg

产品规格及设计如有变更，恕不另行通知。
中英文版本如有出入，一概以中文版为准。
本产品使用说明书以 www.germanpool.com 网上版为最新版本。

生产者：德国宝（香港）有限公司

地址：香港九龙土瓜湾马头角道116号新宝工商中心二期113号室

执行标准：GB4706.1-2005, GB4706.14-2008

3C证书编号：2017010712964245

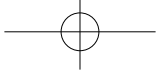

Content

Precautions	15
Product Features	17
Product Structure	18
Operating Instructions	19
Care & Maintenance	23
Accessories	24
Troubleshooting	25
Technical Specifications	26
Warranty Terms & Conditions	27

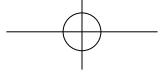

Precautions

Important

- For safety purpose, read the instructions carefully before using the appliance. Keep the user manual for future reference.
- The appliance is designed for domestic use and should be operated in accordance with the following instructions.
- DO NOT use this appliance with charcoal or any similar combustible materials.

New Safety Feature: Lid Lock Protection Button Operating Guide

Lifting the lid

① Pull up to lift the lid.



② When the lid is fully lifted, Lid Lock Protection Button will be pushed upwards. The lid will be locked.

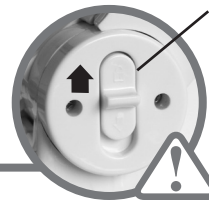

Lid is locked if the safety lock is pushed upwards.

Closing the lid

③ Incline the lid slightly backward and press the safety lock downwards to unlock it.

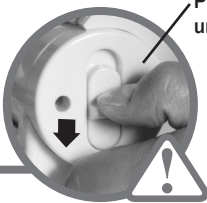

Press the safety lock downwards to unlock the lid.

④ Keep pressing the safety button while gently closing the lid.

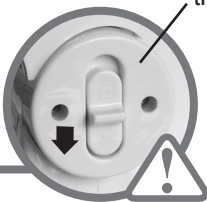

The safety lock stays in the lower position, meaning that the lid is unlocked.

Attention:

- Do not close the lid without pressing the Safety Lock downwards, otherwise it may damage the lid arm.
- While closing the lid, press the safety lock and grasp the lid handle to avoid crashing into the pot.

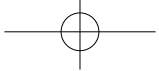

Precautions

1. Use the dedicated plug for the appliance. Do not overload the AC socket.
2. Before activating the appliance, make sure the lid is firmly closed.
3. If the appliance is operated on a non-heat resistant table, place a heat-proof mat under the appliance prior to usage.
4. This appliance is intended to be used in household and similar indoor environment such as:
 - staff pantry in shops, offices and other working environments;
 - farm houses;
 - hotels, motels and other residential apartments;
 - Bed and Breakfast (B&B) lodges.
5. This appliance is not intended to be operated by means of an external timer or a separate remote-control system.
6. During its first time usage or when the glass container is cool, preheating the pot will help deliver better cooking results.
7. To avoid the risk of scald, do not touch the glass container or the lid during its operation until the container cools down.
8. Food must be placed on a rack inside the glass container. Make sure there is enough space between food and the heating element so that interior airflow circulation will not be blocked.
9. Do not pour water or put other air-impermeable objects or non-heat-resistant containers (like plastics) inside the cooking pot during its operation.
10. Disconnect the appliance from the AC socket after usage.
11. Unplug the device and let it completely cool down before cleaning or washing.
12. Do not rinse the cooking pot or immerse it into water. Wipe it with a soft and wet wrung-out cloth to remove oily stains. Do not clean it with alcohol or other VOCs.
13. Avoid knocking, hitting or striking the cooking pot, which may cause invisible cracks on the pot.
14. There should be a distance of at least 10 cm between the appliance and the wall.
15. The appliance is not intended to be used by persons (including children) with reduced physical, sensory or mental capabilities, or any individual lacking relevant experience and skill, unless they have been given instructions or under the supervision of responsible personnel.
16. Keep children away from the appliance.
17. When strange noise is heard or severe vibration occurs, never lift the lid. Disconnect it from the power source immediately and contact German Pool or a qualified technician for repair.
18. If the power cord is damaged or malfunction occurs, do not attempt to disassemble, repair or modify the appliance. It must be replaced or repaired by German Pool or other qualified technicians.
19. To avoid electric shock, short-circuit or fire hazards, never use a damaged cord or plug.
20. DO NOT operate this product with an external timer or independent remote control system.

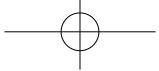

Product Features

Multiple Functions

The adaptable nature of German Pool's Multi-Purpose Halogen Cooking Pot can serve as an electric grill, conventional oven, rice cooker, egg cooker, electric oven, toaster, stewing pot, bread maker, baking machine, steriliser, steamer, popcorn maker, hotdog maker and etc.

Healthy Cooking

The Multi-Purpose Halogen Cooking Pot requires no oil to cook food, such as potato chips, hash browns, peanuts, cashew nuts, fish and other pickled food products, so that healthier cooking can be achieved. Heat waves produced by the halogen heating element can penetrate directly into food and boil its fat content, which can effectively reduce fat consumption.

Time- & Energy-Efficient

The Multi-Purpose Halogen Cooking Pot transfers heat to food through simultaneous convection, conduction and penetration. As a result, food can be cooked within a much shorter time. Owing to its circular heating element and the patented internal venting system, German Pool Halogen Pot can transfer circulating heat from multidirectional perspective in order to realise energy efficient cooking.

Fumeless Cooking

With German Pool's Multi-Purpose Halogen Cooking Pot, no oily fumes or radiation will be produced in the cooking process. In addition, its modern and enclosed design will enlarge the culinary boundary from the kitchen to the living room.

Easy Cleaning

German Pool's Multi-Purpose Halogen Cooking Pot comes with a powerful self-cleaning function. Thanks to the ability to generate high speed circulating heat, the cooking pot can effortlessly decompose tough stains and grease within minutes.

Product Material:

Glass pot & lid	High / Low Rack	Frying Pan	Ring Extension	Baking Pan	Plate Lifter
Glass	304 Stainless Steel	Non-Stick Coating 1	410 Stainless Steel	430 Stainless Steel	304 Stainless Steel



Using Conditions:

1. Direct contact with food
2. Food might be contacted: all kinds of food
3. Maximum operation temperature and time: 250 °C · 119min
4. Reusable: yes
5. User guide: clean the device with water before use

Product Structure

Unit Body

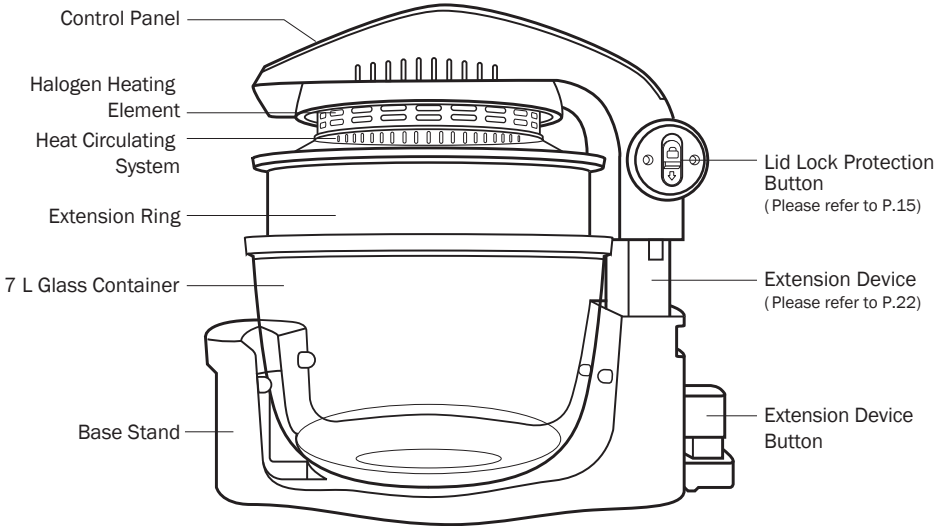

Control Panel

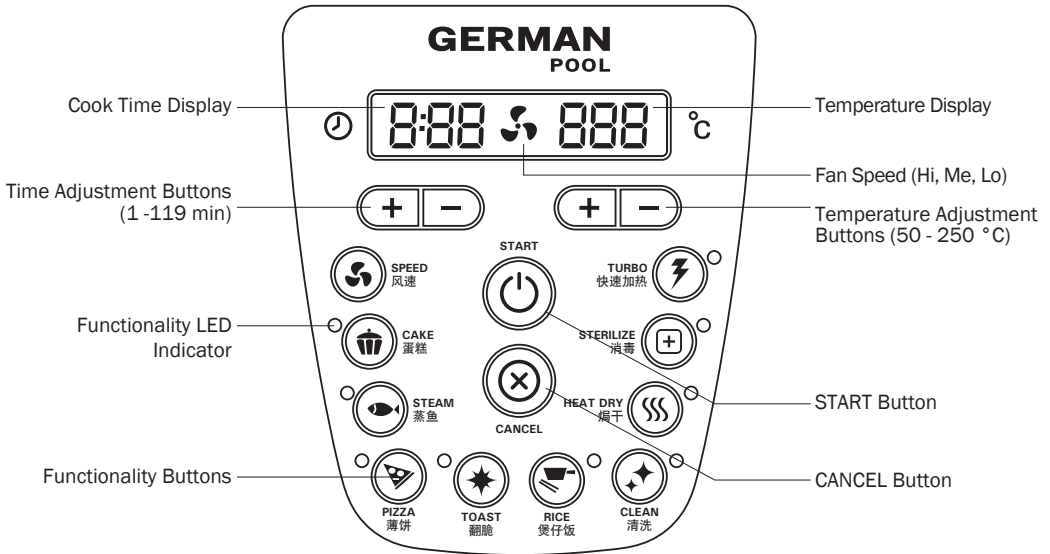

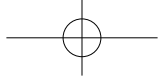

Operating Instructions

Attention

- As a safety measure, when the lid is lifted, the heating element and fans will be switched off. When it is closed, the unit will continue its operation.
- If a cookware is to be placed inside the glass container, use something that is made of metal and place it on a rack to ensure that food is evenly cooked. There should be a distance of at least 3 cm between the food and the lid.
- Do not touch the glass container while cooking is in progress. Keep children away from the unit to prevent injuries.

Basic Operation

Switching on the Unit:

Power up the appliance. A “dee” sound will be emitted and the digital screen will display the initial time and temperature as , meaning that the machine is in standby mode.

Watch the video clip



Time Adjustment:

Each press on the “+” or “-” button will increase or decrease the cooking time by 1 minute. Keep pressing the button for a 10-minute adjustment. The maximum work time is 1 hour and 59 minutes.

Temperature Adjustment:

Press the “+” or “-” button to increase or decrease the cooking temperature. The first press will result in 50 °C adjustment and every subsequent press will bring about 10 °C adjustment. The adjustable temperature range is 50 °C – 250 °C.

Start Up:

Choose the cooking mode and set the required time and temperature. Press the “START” button to begin cooking.

Cancel:

Press “CANCEL” button to return to standby mode. (The fan will keep operating until the oven temperature drops below 100 °C. The program has to be reset to continue cooking.)

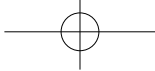

Operating Instructions

Pause:

Cooking will be paused if the lid is lifted. The time and temperature reading will freeze and will be automatically saved. All buttons (except the “Cancel” button) will be deactivated. The fan and heating elements will stop working until the lid is closed.

Cooking:

After setting the time and temperature, press the “START” button to begin. While cooking is in progress, users can freely adjust the time and temperature, whereas functionality buttons will be deactivated. When cooking is done, the heating element will stop working, but the fan will keep operating until the oven temperature drops below 100 °C. Then a “dee” sound will be emitted and the screen display will return to the initial reading.

Cooking Mode Selection:

Select the desired functionality, the default time and temperature will appear on the control panel. The LED indicator adjacent to the functionality button will flash. Press the “START” button to begin cooking, then the LED indicator will stop flashing and light up. When the fan stops operating, the reading on the screen display will return to the initial value and the LED indicator adjacent to the functionality button will extinguish.





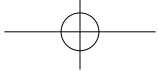





Fan Speed Selection:

Press the “SPEED” button to change the fan speed (HI: 2100 R/min; ME: 1600 R/min; LO: 1100 R/min). The default speed is HI. Fan Speed can be adjusted prior to or during cooking. The fan icon  shown on the control panel will rotate at a pace in accordance with the selected fan speed. The icon will cease to rotate when the fan stops working.



Operating Instructions

Functionality

Button	Default time / temp.	Explanation
 Speed	–	Adjustable fan speed: high, medium, low
 Rice	30min/250 °C	30min/250 °C optimal temperature and time for each of the cooking mode have been predetermined to deliver the best cooking result. (Time and temperature can be further adjusted according to user preference.)
 Cake	16min/160 °C	
 Steam	40min/250 °C	
 Pizza	3min/250 °C	
 Toast	5min/250 °C	Strong heat is applied to food within a short time to deliver a crispy outer layer. This mode is particularly suitable for reheating cooked food.
 Clean	10min/250 °C	Using the heating element and heat circulation system to generate uniform thermal distribution for breaking down tough stains and grease accumulated inside the glass container. Note: Pour water (or detergent) only when the cooking pot has completely cooled down.
 Heat Dry	6min/90 °C	Use low but rapidly circulating heat to remove extra moisture trapped inside food.
 Sterilize	13min/130 °C	Use the heat emitted from the heating element to sterilise food or cooking utensils.
 Turbo	40min/200 °C	Apply strong heat for 40 minutes.

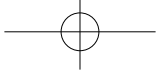

Operating Instructions

Pause Function

- Before cooking finishes, user can pause operation by simply lifting the lid and resume cooking by closing it.
- To stop cooking, press “ CANCEL” and then lift the lid. The Time and temperature settings will be reset.

Lid Lock Protection Button (See P.15)

- Pull up to lift the lid (Fig 1). The lid will be locked when it is fully lifted.
- To close the lid, keep pressing the “ Lid Lock Protection Button” downwards and simultaneously grasp the lid handle to close it (Fig 2).



Fig.1



Fig.2

Extension Device

- Press the Extension Device Button downward to unlock the device and lift the lid to the expanded position (Fig 3).
- Place the Extension Ring on top of the glass container to increase the capacity (Fig 4).



Fig.3



Fig.4

Note:

Do not press the Extension Device Button while moving the product.

Incorrect Operation

Please do NOT :

Touch the lid or glass container with hand during operation.	Overload the power socket.	Pour water into the glass container immediately after operation.

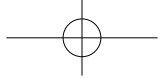

Care & Maintenance

1. Auto-cleaning function: Fill water up to 1/5 of the glass container. Add some mild detergent and press the "CLEAN" button to remove grease stains accumulated inside the glass container.
2. Another cleaning approach is to first remove the glass container, and then use a sponge with mild detergent to wipe it clean.
3. A dishwasher may be used to wash the glass container and the racks. First remove the glass container from its stand prior to washing it in a dishwasher. Never put the lid in a dishwasher.
4. Unplug the device and let it completely cool down before cleaning or washing.
5. Avoid knocking, hitting or striking the cooking pot, which may cause invisible cracks on the pot.
6. Do not immerse the lid in water as it contains delicate electronic components. Wipe and clean it with a soft and dry cloth.
7. The glass container, base stand and supplied accessories can be cleaned with mild detergent. Cool down the entire pot before cleaning.
8. When cleaning is finished, wipe the glass container and the lid with a dry cloth.



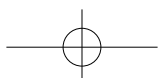
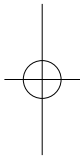
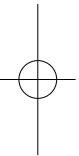

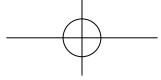
Watch the video clip



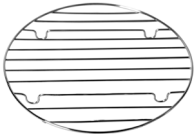
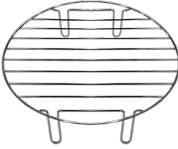

Accessories

Supplied Accessories

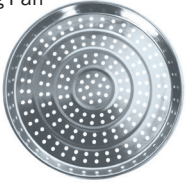
<p>Low Rack</p> 	<p>High Rack</p> 	<p>Plate Lifter</p> 
<p>For larger food items such as grilled duck, grilled chicken, claypot rice, etc.</p>	<p>Allows food to be placed nearer to the heat source, e.g. Skewers; it can be used simultaneously with low rack for multi-level cooking.</p>	<p>To carry food or plate in and out of the cooking pot.</p>
<p>Ring Extension</p> 	<p>Frying Pan</p> 	<p>Baking Pan</p> 
<p>Increase cooking pot capacity by 3 L. Ideal for grilled duck, grilled chicken and multi-level cooking.</p>	<p>For Gyoza dumplings, fish, rice roll and etc.</p>	<p>For baking small items such as nuts, french fries, Chinese herbs, cookies and etc.</p>

Optional Accessory

<p>Casserole Pot With Cover</p> 
<p>Suitable for rice, claypot rice, cakes, noodles, soup and etc.</p>

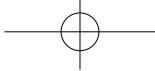

Troubleshooting

If the following problems are encountered, follow the instructions below. If the problem persists, please contact our Customer Services and Repair Centre.

Note: For safety purpose, any unauthorised attempt to dismantle the product is prohibited.

Phenomenon	Solution
Release of smoke during its first operation.	<ul style="list-style-type: none">Heat the empty glass container at the highest temperature 250°C for 5 minutes. This will evaporate the protective grease coating.
Failure to operate the appliance.	<ul style="list-style-type: none">Check whether the power cord is properly plugged into both the socket and the main body. Check whether the lid is closed. (Note: When the lid is not completely closed, the appliance will not function.)
Cooking pot does not heat up.	<ul style="list-style-type: none">Check whether the appliance is set to operate at a high enough temperature.
Motor fan continues to operate after cooking.	<ul style="list-style-type: none">To cool down the appliance, the fan will keep operating until the temperature falls below 100°C.
The lid or glass container is cracked.	<ul style="list-style-type: none">Order replacement at German Pool's Customer Services and Repair Centre.

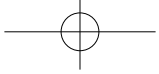

Technical Specifications

Model	CKY-298
Voltage	220 V
Frequency	50 Hz
Power	1,000 W
Thermostat	50 - 250 °C
Timer	1 - 119 min
Cooking Pot Dimension (With Base Stand)	(H) 322 mm (W) 277 mm (D) 405 mm
Container Dimensions	(H) 172 mm (Ø) 277 mm
Capacity	7 (+3) L
Net Weight	4.34 kg

Specifications are subject to change without prior notice.

If there is any inconsistency or ambiguity between the English version and the Chinese version, the Chinese version shall prevail.
Refer to www.germanpool.com for the most up-to-date version of the Operating Instructions.

Manufacturer: German Pool (Hong Kong) Limited

Address: Room 113, Newport Centre Phase II, 116 Ma Tau Kok Road, Tokwawan, Kowloon, Hong Kong

Standard: GB4706.1-2005, GB4706.14-2008

3C Certificate No.: 2017010712964245

保用条款

此保用提供德国宝产品之机件在正常使用下一年保用(自购买日起计算)。

* 贵户须在购机十天内, 以下列其中一种方式向本公司登记资料, 保用手续方正式生效:

1) 填写本公司网页内之保用登记表格
www.germanpool.com.cn

2) 填写保用登记卡, 邮寄至本公司。



Warranty Terms & Conditions

Under normal operations, the product will guarantee a 1-year full warranty provided by German Pool (effective from the date of purchase).

* This warranty is not valid until customer registration information is received by our Service Centre within 10 days of purchase via one of the following means:

1) Visit our website and register online:
www.germanpool.com/warranty

2) Complete all the fields on the attached Warranty Card and mail it back to our Customer Service Centre.



另请填写以下表格并与正本发票一并保存, 以便维修时核对资料。用户提供之所有资料必须正确无误, 否则免费保用将会无效。 Please fill out the form below. This information and the original purchase invoice will be required for any repairs. Warranty will be invalidated if information provided is found to be inaccurate.

型号 Model No.: CKY-298

机身号码 Serial No.: _____ 发票号码 Invoice No.: _____

购买商号 Purchased From: _____ 购买日期 Purchase Date: _____

1. 未能出示购买发票正本者, 将不获免费维修服务。
2. 用户应依照说明书的指示操作。本保用并不包括:
 - 上门安装、检验、维修或更换零件之人工以及一切运输费用;
 - 因天然与人为意外造成的损坏(包括运输及其他);
 - 电源接合不当、不依说明书而错误或疏忽使用本机所引致之损坏。
3. 于下列情况下, 用户之保用资格将被取消:
 - 购买发票有任何非认可之删改;
 - 产品被用作商业或工业用途;
 - 产品经非认可之技术人员改装或加装任何配件;
 - 机身编号被擅自涂改、破坏或删除。
4. 总代理有权选择维修或更换配件或其损坏部份。
5. 产品一经被转让, 其保用即被视作无效。

1. Customer who fails to present original purchase invoice will not be eligible for free warranty service.
2. Customer should always follow the operating instructions. This warranty does not apply to:
 - labour costs for on-site installation, check-up, repair, replacement of parts and other transportation costs;
 - damages caused by accidents of any kind (including material transfer and others);
 - operating failures resulting from applying incorrect voltage, improper usage, and unauthorized installations or repairs.
3. This warranty is invalid if:
 - the purchase invoice is modified by an unauthorized party;
 - the product is used for any commercial or industrial purposes;
 - the product is repaired or modified by unauthorized personnel, or unauthorized parts are installed;
 - the serial number is modified, damaged or removed from the product.
4. German Pool will, at its discretion, repair or replace any defective part.
5. This warranty will be void if there is any transfer of ownership from the original purchaser.

客户服务中心

全国服务热线:

+86 400 830 3838

传真: 0086-757-22196809

电邮: repairs@germanpool.com.cn

地址: 广东省佛山市顺德区大良五沙工业区新翔路8号

Address: 8th, Xinxiang Road, Wusha Industrial Park, Daliang, Shunde, Foshan, Guangdong

Customer Service Centre

China Customer Service Hotline:

+86 400 830 3838

Fax: 0086-757-22196809

Email: repairs@germanpool.com.cn

此保用只适用于中国 | This warranty is valid only in China

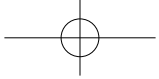

GERMAN POOL

授权方：德国宝（香港）有限公司
制造商：佛山市顺德区力进贸易有限公司



香港 (S MARK)
安全認證



中國標榜/家電行業
十大影響力品牌

CEO

CEO非凡品牌大賞



香港優質商號



香港工商業獎



2007
最具潛質
創建品牌企業獎



香港中小企業
最佳拍檔大獎



HONG KONG
CONSUMER CHOICE
2007



香港 (O 標)
優質服務證書



香港名牌十年成就獎
HONG KONG TOP BRAND TEN YEAR
ACHIEVEMENT AWARD

© 版权所有。未获德国宝授权，不得翻印、复制或使用道具作任何商业用途，违者必究。

© All rights reserved. Copying, reproducing or using the contents of this manual is not allowed without prior authorization from German Pool, violators will be prosecuted.

www.germanpool.com

HPX-CKY298-M-25(4)_CN